

TASC Series

STAND-ALONE THERMAL
PAN & TILT SECURITY CAMERAS



OPERATOR'S MANUAL (TASC Series) REV. 1 – SEPT., 2014

operator's manual

Important Export Restrictions! Commodities, products, technologies and services contained in this manual are subject to one or more of the export control laws and regulations of the U.S. Government and they fall under the control jurisdiction of either the US Department of State or the US BIS-Department of Commerce. It is unlawful and strictly prohibited to export, or attempt to export or otherwise transfer or sell any hardware or technical data or furnish any service to any foreign person, whether abroad or in the United States, for which a license or written approval of the U.S. Government is required, without first obtaining the required license or written approval from the Department of the U.S. Government having jurisdiction. Diversion contrary to U.S. law is prohibited.



**AMERICAN
TECHNOLOGIES
NETWORK
CORP.**

**Register your product warranty online at
www.atncorp.com/warranty**

Manual (TASC Series) Revision 1 – September, 2014

The information in this manual furnished for information use only, is subject to change without notice, is not to be construed as a commitment by ATN Corp. ATN Corp. assumes no responsibility or liability for any errors or inaccuracies that may appear in this book.

© 2014 ATN Corp. All right reserved.

SAFETY SUMMARY

STUDY CAREFULLY THIS MANUAL BEFORE TURNING ON AND OPERATING THIS PRODUCT.

CAUTIONS

The TASC Series Stand-Alone Thermal Pan & Tilt Security Cameras are precision electro-optical instruments and requires careful handling. To provide safe use of the systems the following instructions should be observed:

- Do not dismantle the device.
- Keep the device clean; protect it from moisture, sharp temperature drops and shocks.
- Be careful not to touch the glass surfaces. If you put finger-prints on, or contaminate the glass surfaces, use only clean and soft materials to clean it.
- Do not leave the device in on position during stops in operation.
- Remove the batteries from the device for the period of storage.

CAUTION:

THIS PRODUCT CONTAINS NATURAL RUBBER LATEX WHICH MAY CAUSE ALLERGIC REACTIONS.

WARNING

Be careful in transportation.

Damages caused by stress, strong vibration and soak should be avoided during the transportation and storage process. Any damage occurs in the retransportation after assembling is not in the warrant prepared range.

WARNING

What should you do when the equipment fails.

If this equipment smoke, strange smell or function failure you should turn off the power supply immediately and stop using it, then contact with the company or dealer.

WARNING

Do not take the equipment apart or change its configuration.

Do not open the house arbitrarily; otherwise the damages would be meeting. If the inner setting and repair are needed, please contact the company or dealer.

WARNING

Do not put other stuff in the equipment.

Make sure that there are not flammable and metal stuff which will cause fire short circuit, damage in equipment. If water or other liquid flow in the equipment, turn the power supply off and cut the power line, then contact with the company or dealer.

WARNING

Be far away from electric field and magnetic field.

The image will be influenced by electromagnetic field when the equipment was fixed near the TV, transmitter, electromagnetic equipment, electric motor.

WARNING

Avoid humidity, dust, high temperature.

To avoid damage, please don't fix the equipment in places with smoke, high temperature, and humidity.

WARNING

Clean.

Clean the equipment with soft cloth. Firstly, put the cloth into the detergent solution, and then wring out water before you wipe the equipment. Lastly, wipe again with dry clean cloth. Don't use gasoline, paint thinner and other chemicals to clean the shell of the equipment, otherwise, it would distortion and paint peeling

WARNING

Do not image extremely high intensity radiation sources.

Do not image extremely high intensity radiation sources, such as the sun, laser, arc welders, etc. This warning applies whether or not the system is powered.

WARNING

Do not try to repair the unit by yourself.

Do not try to repair the unit by yourself. We shall not be responsible for any problem caused by unauthorized amendment or repairing.

TABLE OF CONTENTS

CHAPTER 1. INTRODUCTION	1-1
1.1. General Information	1-2
1.1.1. Camera	1-2
1.1.2. Reports	1-2
1.1.3. Storage	1-2
1.1.4. Warranty Information	1-3
1.2. Description and Data	1-5
1.2.1. Description	1-5
1.2.2. Technical parameters	1-7
CHAPTER 2. ASSEMBLY AND PREPARATION	2-1
2.1. Preparation.	2-2
2.1.1. Preparation for Use	2-2
2.1.2. Dimension drawing	2-2
2.2. Installation guide	2-4
2.2.1. Wall mount	2-4
CHAPTER 3. OPERATION GUIDE (For analog use)	3-1
3.1. General Information	3-2
3.1.1. Self test	3-2
3.1.2. Control the direction of camera	3-2
3.1.3. Scan.	3-2
3.1.4. Set preset	3-2
3.1.5. Call preset.	3-2
3.1.6. Program Tour	3-3
3.1.7. Call Tour.	3-3
3.1.8. Set Home Point	3-4
3.1.9. Left And Right Limit Scan	3-4
3.1.10. Restore Factory Default	3-4
3.1.11. Speed Dome Command List.	3-4
3.1.12. The monitoring program (I.P.)	3-6

CHAPTER 4. MAINTENANCE INSTRUCTIONS	4-1
4.1. Troubleshooting procedures	4-2
4.1.1. Troubleshooting procedures.	4-2
4.2. The general knowledge of RS485.	4-3
4.2.1. Basic characteristic of RS485.	4-3
4.2.2. RS485 transmitting distance	4-3
4.2.3. Connect mode and terminal impedance	4-3
4.2.4. Question in applications.	4-4
CHAPTER 5. APPENDIX	5-1

HOW TO USE THIS MANUAL

- **Usage**

You must familiarize yourself with the entire manual before operating the equipment. Read and follow all warning notices.

- **Manual Overview**

The table of contents includes the paragraph number, paragraph title, and page number. An index provides additional references to the subject contents.

CHAPTER 1

INTRODUCTION

1.1. GENERAL INFORMATION

1.1.1. CAMERA

This manual contains instructions for use in operating and maintaining the TASC Series Stand-Alone Thermal Pan & Tilt Security Cameras. Throughout this manual, the TASC Series will be referred to as the scope or TASC.

1.1.2. REPORTS

Reports from the user on recommendations for improvements are encouraged. Send reports to the address below.

American Technologies Network Corp.
1341 San Mateo Avenue
South San Francisco, CA 94080
(800) 910-2862
(650) 989-5100
(650) 875-0129 fax
info@atncorp.com
www.atncorp.com

1.1.3. STORAGE

Storage of TASC should be done in the factory packaging and after a thorough PMCS as outlined in Section 4.1 of this manual. This will ensure the camera remains in mission ready condition during storage. Presence of acid and alkaline vapor, as well as of other aggressive admixtures in the air is unacceptable.

1.1.4. WARRANTY INFORMATION

3 YEAR PRODUCT WARRANTY

This product is guaranteed to be free from manufacturing defects in material and workmanship under normal use for a period of 3 (three) years from the date of purchase. In addition the uncooled thermal sensor array carries a 10 year warranty. In the event a defect that is covered by the foregoing warranty occurs during the applicable period stated above, ATN, at its option, will either repair or replace the product, and such action on the part of ATN shall be the full extent of ATN's liability, and the Customer's sole and exclusive remedy. This warranty does not cover a product (a) used in other than its normal and customary manner; (b) subjected to misuse; (c) subjected to alterations, modifications or repairs by the Customer or by any party other than ATN without prior written consent of ATN; (d) special order or "close-out" merchandise or merchandise sold "as-is" by either ATN or the ATN dealer; or (e) merchandise that has been discontinued by the manufacturer and either parts or replacement units are not available due to reasons beyond the control of ATN. ATN shall not be responsible for any defects or damage that in ATN's opinion is a result from the mishandling, abuse, misuse, improper storage or improper operation, including use in conjunction with equipment which is electrically or mechanically incompatible with or of inferior quality to the product, as well as failure to maintain the environmental conditions specified by the manufacturer. This warranty is extended only to the original purchaser. Any breach of this warranty shall be waived unless the customer notifies ATN at the address noted below within the applicable warranty period.

The customer understands and agrees that except for the foregoing warranty, no other warranties written or oral, statutory, expressed or implied, including any implied warranty of merchantability or fitness for a particular purpose, shall apply to the product. All such implied warranties are hereby and expressly disclaimed.

LIMITATION OF LIABILITY

ATN will not be liable for any claims, actions, suits, proceedings, costs, expenses, damages or liabilities arising out of the use of this product. Operation and use of the product are the sole responsibility of the Customer. ATN's sole undertaking is limited to providing the products and services outlined herein in accordance with the terms and conditions of this Agreement. The provision of products sold and services performed by ATN to the Customer shall not be interpreted, construed, or regarded, either expressly or implied, as being for the benefit of or creating any obligation toward any third party of legal entity outside ATN and the Customer; ATN's obligations under this Agreement extend solely to the Customer.

ATN's liability hereunder for damages, regardless of the form or action, shall not exceed the fees or other charges paid to ATN by the customer or customer's dealer. ATN shall not, in any event, be liable for special, indirect, incidental, or consequential damages, including, but not limited to, lost income, lost revenue, or lost profit, whether such damages were foreseeable or not at the time of purchase, and whether or not such damages arise out of a breach of warranty, a breach of agreement, negligence, strict liability or any other theory of liability.

PRODUCT WARRANTY REGISTRATION

In order to validate the warranty on your product, ATN must receive a completed Product Warranty Registration Card for each unit or complete warranty registration on our website at www.atncorp.com. Please complete the included form and immediately mail it to our Service Center: ATN Corporation, 1341 San Mateo Avenue, South San Francisco, CA 94080.

OBTAINING WARRANTY SERVICE

To obtain warranty service on your unit, End-user must notify ATN service department by calling 800-910-2862 or 650-989-5100 or via e-mail service@atncorp.com to receive a Return Merchandise Authorization number (RMA).

When returning please take or send the product, postage paid, with a copy of your sales receipt to our service center, ATN Corporation at the address noted above. All merchandise must be fully insured with the correct postage; ATN will not be responsible for improper postage or, missing or damaged merchandise during shipment.

When sending product back, please clearly mark the RMA# on the outside of the shipping box. Please include a letter that indicates your RMA#, Name, Return Address, reason for service return, Contact information such as valid telephone numbers and/or e-mail address and proof of purchases that will help us to establish the valid start date of the warranty. Product merchandise returns that do not have an RMA listed may be refused or a significant delay in processing may occur. Estimated Warranty service time is 10-20 business days. End-user/customer is responsible for postage to ATN for warranty service. ATN will cover return postage/shipping to continental USA end-users/customers after warranty repair only if product is covered by aforementioned warranty. ATN will return product after warranty service by domestic ground service and/or domestic mail. Any other requested, required or international shipping method the postage/shipping fee will be the responsibility of the end-user/customer.

1.2. DESCRIPTION AND DATA

1.2.1. DESCRIPTION

a. Purpose

The TASC Series Features Built-in Analytics and an Advanced Motion Detector. TASC cameras utilize a state of the art algorithm that significantly reduces false alarms normally caused by natural movement (background) objects such as leaves, clouds or small animals. The Object Tracking function, when activated will capture and track all moving objects and register their path in the field of view. The Object Counting function counts all captured objects. The Trip Wire function allows users to set up any configuration of virtual tripwires in the field of view, that when crossed in a preset direction, will trigger an alarm. It's the perfect solution for passages, drive-ways or perimeter security. Trip Wire can also be used to detect the wrong direction of movement on roads. The speed measurement feature turns your TASC camera into a speed radar that automatically measures and records the speed of all moving objects in your field of view. When applied inside Clean Zone can also set off an alarm when a moving object exceeds user preset speed limit. The Clean Zone solution allows users to set up a perimeter and create alarm rules that best resolve specific security issues by activating any combination of functions mentioned above as well as Clean Zone specific algorithms such as Loitering Detection and Dropped Objects Detection. The Loitering Detection function sets off an alarm if an object stays in the Clean Zone longer than a specified period of time. The Dropped Objects Detection function alarms user of all objects left in the field of view. Tampering alarm informs an operator if the camera is mechanically manipulated with or if the view is obscured.

ATN Corp is proud to present the new TASC series Thermal Acquisition Security Cameras! 18 years of experience in enhancing vision, vast expertise in development of thermal devices and recent advances in electronics enable us to create these easy to use products with an unmatched set of skills that also come at very reasonable price. Our new cameras utilize advanced thermal tech-

nology and optics used in the universally recognized ThOR series scopes, together with Pan/Tilt capabilities, state of the art built-in analytics and features like autofocus that were previously available only in top-end professional models. The TASC series caters to the most important need we all share — the need for security. We truly believe that it can become an invaluable instrument in outperforming potential threats to personal security and safety of your possessions.

b. Function Description

1. Focus length/rotation speed auto matching technology

In the situation that focal length is long, the imager will be distorted because thermal speed dome responses so fast that even a tender touch of joystick could make the picture shift rapidly. Based on human design, this speed dome thermal imaging camera can automatically adjust pan and tilt speed according to the focal length to make the manual trace operation easier.

2. Automatically flip

If operator keeps pressing the joystick after reaching the limitation in vertical direction, the lens would automatically flip 180°, so we can monitor the back scene.

3. Set and call preset

Preset is a function that we can store the angle of PTZ and the length of focus to the memory, and the thermal speed dome could adjust itself to reach the angle of PTZ and the length of focus when you call the preset.

4. Tour

Automatic tour, which arranges presets in the wanted order and dwell time by programming, is a build-in function of this thermal speed dome. With a command, the camera of thermal speed dome would tour automatically and continuously according to the route and dwell time preprogrammed.

5. Automatically scan

This high speed dome camera can automatically and repeatedly scan 360° in both high speed and slow speed.

6. Limit scan

To set the starting point of limit scan by using the limit start command in the control keyboard, then control the joystick to move to the end point of limit scan with a certain speed. After calling the limit scan, camera will automatically scan between the start and end points with the speed which joystick moving.

7. Home point

Home place is a function that if there is no operation in a long time, dome thermal camera would back to a certain important preset place. Waiting time before home point function starting is from 1 to 255 second.

c. Features

TASC has the following important features:

- Advanced Thermal Detectors with resolution 336x256 or 640x515 pixels.
- High quality thermal image with 9/30/60 Hz frame rate.
- Built-in video analytics.
- Designed with low power consumption, standard 8 inch all-alloy housing.
- 360° horizontal continuous rotation. Horizontal for 60°/sec; vertical for 45°/sec.
- Support 128 preset positions, 5 tour routes.
- Against thunder and water, meet IP66 requirements.
- Support automatic reset when the preset has a wrong position.
- Perfect used tool for middle range surveillance, even in total darkness, light fog or smoke.

1.2.2. TECHNICAL PARAMETERS

Technical parameters of ATN thermal pan&tilt smart camera see table below

MODEL		TASC 336-7	TASC 336-13	TASC 336-26	TASC 336-50	TASC 640-13	TASC 640-26	TASC 640-50
Detector characteristics	Detector type	FLIR						
	Array size	320x240 pixels		640 x 480 pixels				
	Frame rate	60 Hz/ 9 Hz		30 Hz/ 9Hz				
	Pixel size	17 µm						
Optics	Lens	7 mm	13 mm	26 mm	50 mm	13 mm	26 mm	50 mm
	Focus	Fixed						
	Field of View	44.5°	25°	12.5°	6.5°	45.4°	23.6°	12.5°
	Calibration	Automatic						
	Auto flip	After tilt 90°, image will automatically flip 180°						
Built-in Pan & Tilt	Pan range	360° rotating and back-and-forth						
	Home point	1-255 s (adjustable)						
	Tilt range	360° rotating and up-and-down						
	Tilt speed	0.5° to 120°/s						
Image Output	Control mode	IP / Pelco D						
	Polarity	White & black hot						
Environment	Video output	IP protocol / composite						
	Operating temperature	From -40°F to +140°F (-40°C / +60°C)						
	Storage temperature	From -56°F to +149°F (-50°C / +65°C)						
Power supply	Weatherproof rate	IP66						
	Input Voltage	DC 12 V						
Physical characteristics	Power dissipation	3 W						
	Weight	9.1 lb/4.1 kg	9.2 lb/4.2 kg	9.2 lb/4.2 kg	9.5 lb/4.3 kg	9.2 lb/4.2 kg	9.2 lb/4.2 kg	9.5 lb/4.3 kg
	Size	13.8" x 8.7" x 8.7" / 350 mm x 220 mm x 220 mm						

CHAPTER 2

ASSEMBLY AND PREPARATION

2.1. PREPARING FOR INSTALLATION

2.1.1. PREPARATION FOR USE

1. Basic requirement

- All electrical work should comply with the latest local electrical regulation, fire precautions legislation and other relative legislations and regulations.
- Check that whether accessories are complete or not according to packing list. If not, please contact the seller.
- Make sure that the applied and installed place meets the requirement of installation.

2. Check the structure of the applied and installed place

- Make sure that there is enough room to install this product and its accessories.
- Make sure that the ceiling, wall and bracket which would install this thermal speed dome should be able to endure as 4 times weight as speed dome.

3. Set DIP switch (Detailed information can be found in Appendix)

- Set DIP switch according to protocol, baud rate and speed dome IP address .
- RS485 jumper setting.

4. Please keep all the safe packing material of thermal dome

Please keep the safe packing material of thermal dome after taking apart the package. If there are some problems with the dome, please pack with the original package and send it back to manufacturer.

NOTE

Non-original package will cause the unexpected damage during transportation.

2.1.2. DIMENSION DRAWING

Appearance:

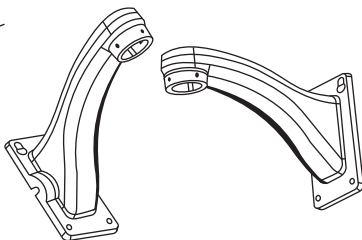
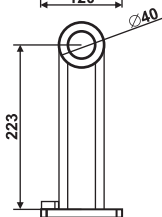
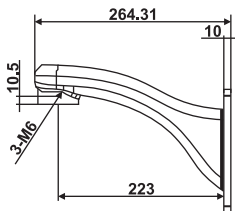
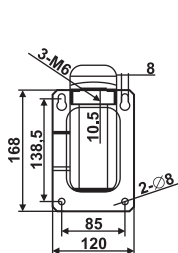
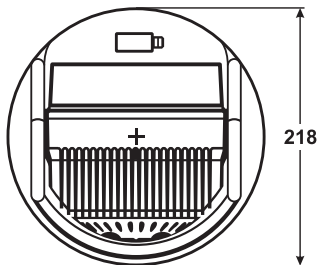
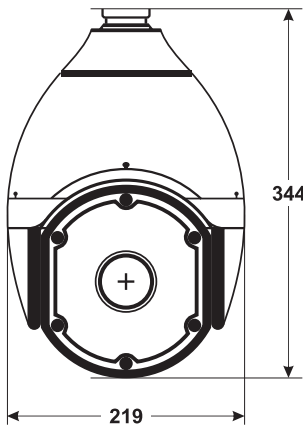

2.2. INSTALLATION GUIDE

2.2.1. WALL MOUNT

NOTE

If the machine is installed outside, make sure the air tightness of thermal speed dome is good and keep away from the place with high temperature or humidity.

There are so many kinds of brackets, so we just introduce the process of installation of thermal speed dome. The installation of bracket please refer to bracket installation guide.

Steps a. Take the bracket base as a template to mark the Positions Of the holes which should be drilled in the wall.

Steps b. Put video cable, power supply cable and control signal through the cavity of bracket. Leave cables enough long outside the bracket.

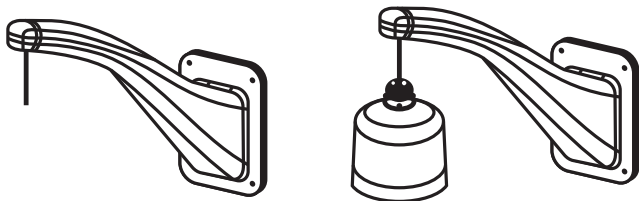

CHAPTER 3

OPERATION GUIDE

(FOR ANALOG USE)

3.1. GENERAL INFORMATION

NOTE

These operating instructions cover the basic operation and features of the dome.

3.1.1. SELF TEST

After the intelligent speed dome was powered on, the camera pan and tilt automatically. And then it zoom from the nearest position and stop in the farthest position. It could ensure that the speed dome is in working order by self-testing.

3.1.2. CONTROL THE DIRECTION OF CAMERA

We should press the number of IP address of camera, and then press SHOT key to call the camera to monitor, then we can make thermal camera move up or down, left or right by moving joystick (joystick not included).

3.1.3. SCAN

Call preset 120 (Detailed information about how to call preset will follow in this page) to start slow scan. Call preset 121 to start fast scan.

3.1.4. SET PRESET

Press the ACK key and SHOT key in the keyboard at the same time to enter setting status. Firstly, move the joystick to find a desired preset position and focal length, then press the number key to enter the preset number. Secondly, press SHOT key, then press ON key. At last, press ACK key and SHOT key at the same time to exit setting status.

3.1.5. CALL PRESET

Enter the preset number then press SHOT key to call the preset wanted, then the camera will immediately move to the preset position and automatically change to focal length of preset you called.

3.1.6. PROGRAM TOUR

Tour is a function that camera could automatically move among some presets according to a programmed route and dwell time after calling it.

- Five tour(100,101,102,103,104) is available in this product.
- Each tour have 16 presets. If the presets are less than 16, the last preset number should be set 119 ,then exit. If the presets are more than 16, system will automatically save the former 16 presets. The dwell time must be set more than 3 seconds. If the dwell time is less than 3 seconds, the system will automatically set 3 seconds as default dwell time.

Case 1: Set the first tour which includes 5 presets. The number of the five presets are 1 → 10 → 15 → 16 → 21, dwell time is 6 seconds.

- Set preset 100 which corresponding to the first tour (please refer the section about how to set preset)
- Set preset 6 which corresponding to the dwell time.
- Set preset 1 (the tour consists of preset 1)
- Set preset 10 (the tour consists of preset 10)
- Set preset 15 (the tour consists of preset 15)
- Set preset 16 (the tour consists of preset 16)
- Set preset 21 (the tour consists of preset 21)
- Set preset 119 (exist the tour programming)
- Press ACK and SHOT at the same time to exit setting status.

3.1.7. CALL TOUR

Call tour 1 by calling preset 100, Call tour 2 by calling preset 101, call tour 3 by calling 102, call tour 4 by calling preset 103,call tour 5 by calling preset 104.

Case 2: The Tour 1, which have five presets in the order like 1 → 10 → 15 → 16 → 21, and the dwell time of ever preset is six seconds, was programmed.

Call preset 100 which corresponding to tour 1 (please refer the section about how to call preset).

After calling tour 1, the speed dome camera will move like this: 1 → dwell six seconds → 10 → dwell six seconds → 15 → dwell six seconds → 16 → dwell six seconds → 21 → dwell six seconds → 1 (repeat the tour)...

3.1.8. SET HOME POINT

Home point is a function that speed dome camera will automatically move to a certain important preset which is set beforehand, after a period of time without any operation made by operator. The waiting time before entering into home status can be set from 1 to 255 seconds.

- Firstly, set a preset which you want be the home point.
- Set preset 121 to enter home point setting status.
- Set preset 122 to start home point.
- Set preset 123 to delete home point.

3.1.9. LEFT AND RIGHT LIMIT SCAN

User could set the left scan limit and right scan limit to make thermal speed dome scan between them.

Call the camera to monitor (Enter IP address of camera then press SHOT key).

Set preset 110 to set left limit, then move the joystick to the position where you want to set the right limit. Then set preset 111 to set right limit. At last, move back 30 degree to avoid the speed dome camera does not pan in the right direction.

3.1.10. RESTORE FACTORY DEFAULT

Call preset 150 would eliminate all the function which was set by customer.

3.1.11. SPEED DOME COMMAND LIST

NOTE

Symbol “+” is stand for that the function is available.

Preset number	Speed dome / camera control content	Call preset	Set preset
The functions would fail to be operated if the tour wasn't programmed by customer beforehand			
99	Reset	+	
100	Start the first programmed tour	+	
101	Start the second programmed tour	+	
102	Start the third programmed tour	+	
103	Start the fourth programmed tour	+	
104	Start the fifth programmed tour	+	
115	Start the first default tour (1-16 presets)	+	
116	Start the second default tour (17-32 presets)	+	
117	Start the third default tour (33-48 presets)	+	
118	Start the fourth default tour (49-64 presets)	+	
119	Start the fifth default tour (65-80 presets)	+	
110	Light Limit point		+
111	Right Limit point		+
112	Call left and right limit scan	+	
113	Open lens/rotation auto match function	+	
114	Close lens/rotation auto match function	+	
120	Pan slowly	+	
121	Pan quickly	+	
121	Set Home point		+
122	Open Home point		+
123	Delete Home point		+
150	Restore factory default	+	
Open/Close	Enter/ exist menu (some models are available)		

3.1.12. THE MONITORING PROGRAM (I.P.)

The monitoring program of TASC cameras: ADM (ATN Device Manager).

When launched the program starts searching in the local network for the compatible cameras and adds them to the list “Device list”. If the camera is outside the local network it should be added manually. When you add the camera (both automatically and manually) you can see the “window” with preview video below. When you choose the camera from the list “Device list” the Camera Control Menu appears in the list “Device”. In order to view the video from the camera you should choose the position “Live video” from the list “Device”.

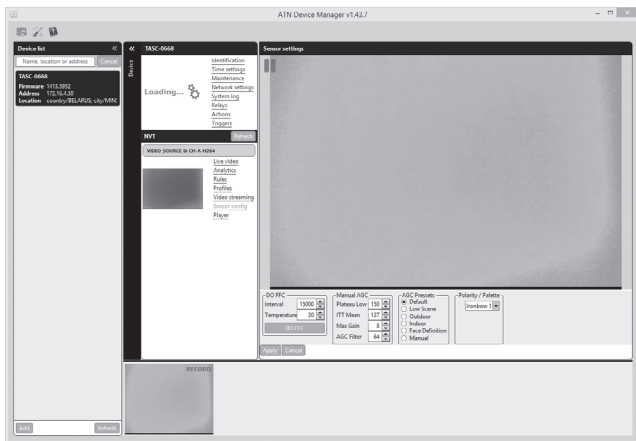

For more information on ONVIF software, please see the user's guide at <http://sourceforge.net/projects/onvifdm/>. Any version of ONVIF not included with the TASC is not supported by ATN.

CHAPTER 4

MAINTENANCE INSTRUCTIONS

4.1. TROUBLESHOOTING PROCEDURES

4.1.1. TROUBLESHOOTING PROCEDURES

Troubleshooting procedures are listed in table below.

PROBLEM	POSSIBLE REASONS	SOLUTION
Thermal speed dome have no action and there is no picture in monitor after power is on.	<ol style="list-style-type: none">1. The end of 24V AC power supply didn't connect with speed dome in right way.2. Power failure or transformer break-down.	<ol style="list-style-type: none">1. Check whether thermal speed dome connect to 24V AC power supply. Make sure that the well connection between speed dome and 24V AC power supply.2. Check whether the power supply is in working order and whether 24V AC transformer work normally.
After self testing, keyboard can't control Thermal speed dome.	<ol style="list-style-type: none">1. IP address Switch of speed dome set incorrectly.2. Reverse connection and open circuit of RS485 control bus.3. RS485 control bus breakdown.	<ol style="list-style-type: none">1. Reset DIP switches according to DIP switch setting table. And make sure that the IP address speed dome is the same with that of keyboard.2. Check connection of RS485 control bus, guarantee well and correct connection.3. Refer to common sense of RS485 control bus.
Fan don't work.	<ol style="list-style-type: none">1. Poor fan connection.2. Ambient temperature is below 10°C	<ol style="list-style-type: none">1. Make sure the well connection. If fan don't work when connection is well, please contact supplier.2. Make sure that thermal speed dome work in proper temperature.
The picture is fuzzy.	<ol style="list-style-type: none">1. Thermal speed dome is in the manual focus status.2. Transparent lower dome is not clean.	<ol style="list-style-type: none">1. Change the manual focus status to auto focus status.2. Clean transparent lower dome.

4.2. THE GENERAL KNOWLEDGE OF RS485

4.2.1. BASIC CHARACTERISTIC OF RS485

RS485 is a half duplex communication bus whose impedance is 120Ω . Its carrying capacity is different because the different connection interface, IC is 32-128 actual load (including master equipment and slaves equipments).

4.2.2. RS485 TRANSMITTING DISTANCE

When 0.56 mm (24AWG) twisted pair line is used as the communication electric cable, there are different transmission distance according to different Baud rate setting. Maximum transmission distance and corresponding.

Baud rate	Maximum distance	Baud rate	Maximum distance
2400 BPS	1800 m	4800 BPS	1200 m
9600 BPS	800 m	19200 BPS	600 m

The max transmission distance would be shortened in conditions as: when this product uses a slim communication electric cable or the thermal speed dome is used in the environment with strong electromagnetic interference or there are many equipments connected to control bus, vice versa.

4.2.3. CONNECT MODE AND TERMINAL IMPEDANCE

The RS485 requires daisy-chain connection mode, and two 120Ω terminal impedances should be connected. The mode was showed as figure 4.1. Simplified connection mode shows in figure 4.2, make sure that the distance of D can't be more than 23 feet (7 meters).

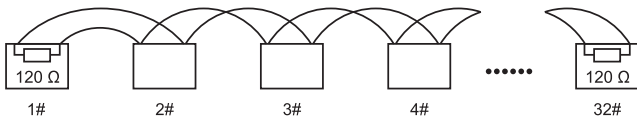

FIGURE 4.1

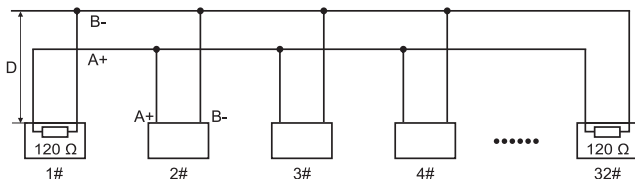

FIGURE 4.2

4.2.4. QUESTION IN APPLICATIONS

In the actual construction, user often adopts y-junction connection mode whose terminal impedance are connected with the furthest two equipments (as B and D in figure 4.3). But it doesn't comply with the use requirement of RS485 industrial standard, so it would lower the reliability of control signal by causing the problems such as signal reflection and a weaker antiinterference ability in the situation that there is long distance among every equipment. Its reflecting phenomenon is that speed dome isn't under the control completely or under control off and on or can't stop from automatically running. We advise to use RS485 alloter which can avoid problems and increase the communication reliability in the situation mentioned above by change y-junction mode to the connection mode complying with RS485 industrial standard.

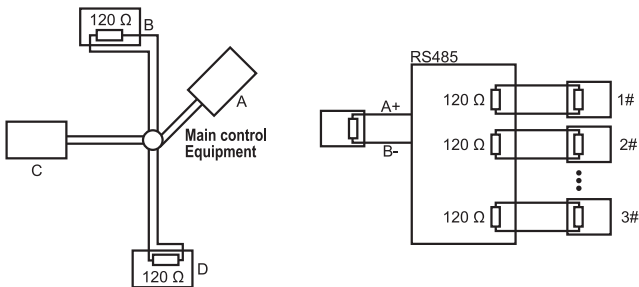

FIGURE 4.3

CHAPTER 5

APPENDIX

SW2 SETTING — IP ADDRESS SETTING

In the following table, “1” stand for “ON” position in IP address switch. “0” stand for “OFF” position in IP address switch.

Address code	IP Address switch							
	1	2	3	4	5	6	7	8
1	1	0	0	0	0	0	0	0
2	0	1	0	0	0	0	0	0
3	1	1	0	0	0	0	0	0
4	0	0	1	0	0	0	0	0
5	1	0	1	0	0	0	0	0
6	0	1	1	0	0	0	0	0
7	1	1	1	0	0	0	0	0
8	0	0	0	1	0	0	0	0
9	1	0	0	1	0	0	0	0
10	0	1	0	1	0	0	0	0
11	1	1	0	1	0	0	0	0
12	0	0	1	1	0	0	0	0
13	1	0	1	1	0	0	0	0
14	0	1	1	1	0	0	0	0
15	1	1	1	1	0	0	0	0
16	0	0	0	0	1	0	0	0
17	1	0	0	0	1	0	0	0
18	0	1	0	0	1	0	0	0
19	1	1	0	0	1	0	0	0
20	0	0	1	0	1	0	0	0
21	1	0	1	0	1	0	0	0
22	0	1	1	0	1	0	0	0
23	1	1	1	0	1	0	0	0
24	0	0	0	1	1	0	0	0
25	1	0	0	1	1	0	0	0
26	0	1	0	1	1	0	0	0
27	1	1	0	1	1	0	0	0
28	0	0	1	1	1	0	0	0
29	1	0	1	1	1	0	0	0

Address code	IP Address switch							
	1	2	3	4	5	6	7	8
30	0	1	1	1	1	0	0	0
31	1	1	1	1	1	0	0	0
32	0	0	0	0	0	1	0	0
33	1	0	0	0	0	1	0	0
34	0	1	0	0	0	1	0	0
35	1	1	0	0	0	1	0	0
36	0	0	1	0	0	1	0	0
37	1	0	1	0	0	1	0	0
38	0	1	1	0	0	1	0	0
39	1	1	1	0	0	1	0	0
40	0	0	0	1	0	1	0	0
41	1	0	0	1	0	1	0	0
42	0	1	0	1	0	1	0	0
43	1	1	0	1	0	1	0	0
44	0	0	1	1	0	1	0	0
45	1	0	1	1	0	1	0	0
46	0	1	1	1	0	1	0	0
47	1	1	1	1	0	1	0	0
48	0	0	0	0	1	1	0	0
49	1	0	0	0	1	1	0	0
50	0	1	0	0	1	1	0	0
51	1	1	0	0	1	1	0	0
52	0	0	1	0	1	1	0	0
53	1	0	1	0	1	1	0	0
54	0	1	1	0	1	1	0	0
55	1	1	1	0	1	1	0	0
56	0	0	0	1	1	1	0	0
57	1	0	0	1	1	1	0	0
58	0	1	0	1	1	1	0	0

Address code	IP Address switch							
	1	2	3	4	5	6	7	8
59	1	1	0	1	1	1	0	0
60	0	0	1	1	1	1	0	0
61	1	0	1	1	1	1	0	0
62	0	1	1	1	1	1	0	0
63	1	1	1	1	1	1	0	0
64	0	0	0	0	0	0	1	0
65	1	0	0	0	0	0	1	0
66	0	1	0	0	0	0	1	0
67	1	1	0	0	0	0	1	0
68	0	0	1	0	0	0	1	0
69	1	0	1	0	0	0	1	0
70	0	1	1	0	0	0	1	0
71	1	1	1	0	0	0	1	0
72	0	0	0	1	0	0	1	0
73	1	0	0	1	0	0	1	0
74	0	1	0	1	0	0	1	0
75	1	1	0	1	0	0	1	0
76	0	0	1	1	0	0	1	0
77	1	0	1	1	0	0	1	0
78	0	1	1	1	0	0	1	0
79	1	1	1	1	0	0	1	0
80	0	0	0	0	1	0	1	0
81	1	0	0	0	1	0	1	0
82	0	1	0	0	1	0	1	0
83	1	1	0	0	1	0	1	0
84	0	0	1	0	1	0	1	0
85	1	0	1	0	1	0	1	0
86	0	1	1	0	1	0	1	0
87	1	1	1	0	1	0	1	0
88	0	0	0	1	1	0	1	0
89	1	0	0	1	1	0	1	0
90	0	1	0	1	1	0	1	0
91	1	1	0	1	1	0	1	0

Address code	IP Address switch							
	1	2	3	4	5	6	7	8
92	0	0	1	1	1	0	1	0
93	1	0	1	1	1	0	1	0
94	0	1	1	1	1	0	1	0
95	1	1	1	1	1	0	1	0
96	0	0	0	0	0	1	1	0
97	1	0	0	0	0	1	1	0
98	0	1	0	0	0	1	1	0
99	1	1	0	0	0	1	1	0
100	0	0	1	0	0	1	1	0
101	1	0	1	0	0	1	1	0
102	0	1	1	0	0	1	1	0
103	1	1	1	0	0	1	1	0
104	0	0	0	1	0	1	1	0
105	1	0	0	1	0	1	1	0
106	0	1	0	1	0	1	1	0
107	1	1	0	1	0	1	1	0
108	0	0	1	1	0	1	1	0
109	1	0	1	1	0	1	1	0
110	0	1	1	1	0	1	1	0
111	1	1	1	1	0	1	1	0
112	0	0	0	0	1	1	1	0
113	1	0	0	0	1	1	1	0
114	0	1	0	0	1	1	1	0
115	1	1	0	0	1	1	1	0
116	0	0	1	0	1	1	1	0
117	1	0	1	0	1	1	1	0
118	0	1	1	0	1	1	1	0
119	1	1	1	0	1	1	1	0
120	0	0	0	1	1	1	1	0
121	1	0	0	1	1	1	1	0
122	0	1	0	1	1	1	1	0
123	1	1	0	1	1	1	1	0
124	0	0	1	1	1	1	1	0

Address code	IP Address switch							
	1	2	3	4	5	6	7	8
125	1	0	1	1	1	1	1	0
126	0	1	1	1	1	1	1	0
127	1	1	1	1	1	1	1	0
128	0	0	0	0	0	0	0	1
129	1	0	0	0	0	0	0	1
130	0	1	0	0	0	0	0	1
131	1	1	0	0	0	0	0	1
132	0	0	1	0	0	0	0	1
133	1	0	1	0	0	0	0	1
134	0	1	1	0	0	0	0	1
135	1	1	1	0	0	0	0	1
136	0	0	0	1	0	0	0	1
137	1	0	0	1	0	0	0	1
138	0	1	0	1	0	0	0	1
139	1	1	0	1	0	0	0	1
140	0	0	1	1	0	0	0	1
141	1	0	1	1	0	0	0	1
142	0	1	1	1	0	0	0	1
143	1	1	1	1	0	0	0	1
144	0	0	0	0	1	0	0	1
145	1	0	0	0	1	0	0	1
146	0	1	0	0	1	0	0	1
147	1	1	0	0	1	0	0	1
148	0	0	1	0	1	0	0	1
149	1	0	1	0	1	0	0	1
150	0	1	1	0	1	0	0	1
151	1	1	1	0	1	0	0	1
152	0	0	0	1	1	0	0	1
153	1	0	0	1	1	0	0	1
154	0	1	0	1	1	0	0	1
155	1	1	0	1	1	0	0	1
156	0	0	1	1	1	0	0	1
157	1	0	1	1	1	0	0	1

Address code	IP Address switch							
	1	2	3	4	5	6	7	8
158	0	1	1	1	1	0	0	1
159	1	1	1	1	1	0	0	1
160	0	0	0	0	0	1	0	1
161	1	0	0	0	0	1	0	1
162	0	1	0	0	0	1	0	1
163	1	1	0	0	0	1	0	1
164	0	0	1	0	0	1	0	1
165	1	0	1	0	0	1	0	1
166	0	1	1	0	0	1	0	1
167	1	1	1	0	0	1	0	1
168	0	0	0	1	0	1	0	1
169	1	0	0	1	0	1	0	1
170	0	1	0	1	0	1	0	1
171	1	1	0	1	0	1	0	1
172	0	0	1	1	0	1	0	1
173	1	0	1	1	0	1	0	1
174	0	1	1	1	0	1	0	1
175	1	1	1	1	0	1	0	1
176	0	0	0	0	1	1	0	1
177	1	0	0	0	1	1	0	1
178	0	1	0	0	1	1	0	1
179	1	1	0	0	1	1	0	1
180	0	0	1	0	1	1	0	1
181	1	0	1	0	1	1	0	1
182	0	1	1	0	1	1	0	1
183	1	1	1	0	1	1	0	1
184	0	0	0	1	1	1	0	1
185	1	0	0	1	1	1	0	1
186	0	1	0	1	1	1	0	1
187	1	1	0	1	1	1	0	1
188	0	0	1	1	1	1	0	1
189	1	0	1	1	1	1	0	1
190	0	1	1	1	1	1	0	1

Address code	IP Address switch							
	1	2	3	4	5	6	7	8
191	1	1	1	1	1	1	0	1
192	0	0	0	0	0	0	1	1
193	1	0	0	0	0	0	1	1
194	0	1	0	0	0	0	1	1
195	1	1	0	0	0	0	1	1
196	0	0	1	0	0	0	1	1
197	1	0	1	0	0	0	1	1
198	0	1	1	0	0	0	1	1
199	1	1	1	0	0	0	1	1
200	0	0	0	1	0	0	1	1
201	1	0	0	1	0	0	1	1
202	0	1	0	1	0	0	1	1
203	1	1	0	1	0	0	1	1
204	0	0	1	1	0	0	1	1
205	1	0	1	1	0	0	1	1
206	0	1	1	1	0	0	1	1
207	1	1	1	1	0	0	1	1
208	0	0	0	0	1	0	1	1
209	1	0	0	0	1	0	1	1
210	0	1	0	0	1	0	1	1
211	1	1	0	0	1	0	1	1
212	0	0	1	0	1	0	1	1
213	1	0	1	0	1	0	1	1
214	0	1	1	0	1	0	1	1
215	1	1	1	0	1	0	1	1
216	0	0	0	1	1	0	1	1
217	1	0	0	1	1	0	1	1
218	0	1	0	1	1	0	1	1
219	1	1	0	1	1	0	1	1
220	0	0	1	1	1	0	1	1
221	1	0	1	1	1	0	1	1
222	0	1	1	1	1	0	1	1
223	1	1	1	1	1	0	1	1

Address code	IP Address switch							
	1	2	3	4	5	6	7	8
224	0	0	0	0	0	1	1	1
225	1	0	0	0	0	1	1	1
226	0	1	0	0	0	1	1	1
227	1	1	0	0	0	1	1	1
228	0	0	1	0	0	1	1	1
229	1	0	1	0	0	1	1	1
230	0	1	1	0	0	1	1	1
231	1	1	1	0	0	1	1	1
232	0	0	0	1	0	1	1	1
233	1	0	0	1	0	1	1	1
234	0	1	0	1	0	1	1	1
235	1	1	0	1	0	1	1	1
236	0	0	1	1	0	1	1	1
237	1	0	1	1	0	1	1	1
238	0	1	1	1	0	1	1	1
239	1	1	1	1	0	1	1	1
240	0	0	0	0	1	1	1	1
241	1	0	0	0	1	1	1	1
242	0	1	0	0	1	1	1	1
243	1	1	0	0	1	1	1	1
244	0	0	1	0	1	1	1	1
245	1	0	1	0	1	1	1	1
246	0	1	1	0	1	1	1	1
247	1	1	1	0	1	1	1	1
248	0	0	0	1	1	1	1	1
249	1	0	0	1	1	1	1	1
250	0	1	0	1	1	1	1	1
251	1	1	0	1	1	1	1	1
252	0	0	1	1	1	1	1	1
253	1	0	1	1	1	1	1	1
254	0	1	1	1	1	1	1	1
255	1	1	1	1	1	1	1	1



For customer service and technical support, please contact

American Technologies Network Corp.

1341 San Mateo Avenue, South San Francisco, CA 94080

phone: 800-910-2862, 650-989-5100; fax: 650-875-0129

www.atncorp.com©